

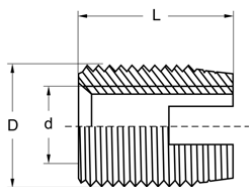

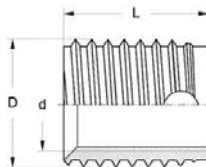



KIT Y ESTUCHES DE CASQUILLOS



KIT ESTANDAR

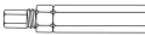

KIT BUJIAS

Rosca Interior	Rosca Exterior	Largo					Referencia	Precio
M 2 x 0,40	M4,5 x 0,50	6	54027	-	4,20	10	02005	35,00
M 2,5x 0,45	M4,5 x 0,50	6	54257	-	4,20	10	02505	35,00
M 3 x 0,50	M 5 x 0,50	6	54037	¼ - 10	4,70	10	06005	35,00
M 4 x 0,70	M 6,5x 0,75	8	54047	¼ - 10	6,10	10	08005	35,00
M 5 x 0,80	M 8 x 1,00	10	54057	¼ - 10	7,50	10	10005	35,00
M 6 x 1,00	M10 x 1,50	14	54067	¼ - 10	9,30	10	14005	35,00
M 8 x 1,25	M12 x 1,50	15	54087	¼ - 10	11,40	10	15005	40,00
M10 x 1,50	M14 x 1,50	18	54107	¼ - 10	13,25	5	18005	50,00
M12 x 1,75	M16 x 1,50	22	54127	¼ - 10	15,25	5	22005	58,00
M14 x 2,00	M18 x 1,50	24	54147	¼ - 10	17,00	5	24005	124,00
M16 x 2,00	M20 x 1,50	22	54167	-	19,00	5	25005	125,00
Rosca Interior	Rosca Exterior	Largo					Referencia	Precio
M10x1,00 Bujías	-	8 y 13	54117 - Bujías		12,4	2 + 2	27005	99,00
M14x1,25 Bujías	M17,7x1,25	9 y 15	54157 - Bujías		17	2 + 2	29005	99,00

Para otras Medidas, CONSULTAR

ESTUCHE DE CASQUILLOS



Medidas	Referencia	Precio
M-3-4-5-6-8-10	30005	198,00

Medidas	Referencia	Precio
M-5-6-8-10-12	30006	198,00

Medidas	Referencia	Precio
M-3-4-5-6-8-10-12	30007	298,00

Cada estuche contiene:

Herramienta de instalación, Broca, Tuerca Montaje, 5 Casquillos de cada medida, Instrucciones.

Para otras Medidas, CONSULTAR

SURTIDO DE CASQUILLOS



Medidas	Referencia	Precio
M-3-4-5-6-8-10-12	9990312	200,00

Contenido del Surtido: 50 Casquillos de cada del M-3-4-5-6-8-10 y 20 Casquillos del M12

HERRAMIENTA INSTALACION DE CASQUILLOS MANUAL Y MAQUINA

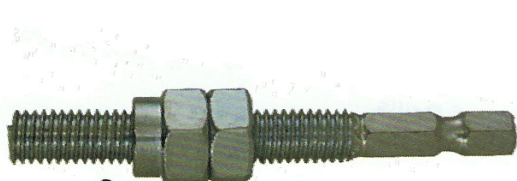

Bujía

Medidas		Referencia	Precio
M 3 x 0,50	¼ Bit	54037	15,00
M 4 x 0,70	¼ Bit	54047	15,00
M 5 x 0,80	¼ Bit	54057	15,00
M 6 x 1,00	¼ Bit	54067	15,00
M 8 x 1,25	¼ Bit	54087	18,00
M10 x 1,50	¼ Bit	54107	20,00
M12 x 1,75	¼ Bit	54127	22,00
M14 x 2,00	¼ Bit	54147	22,00
Medidas		Referencia	Precio
M10 x 1,00	17 mm	54117	32,00
M14 x 1,25	19 mm	54157	36,00

Montaje Casquillos Autorroscantes Para Bujías



HERRAMIENTA INSTALACION DE CASQUILLOS MAQUINA AUTOMATICO



Medidas		Referencia	Precio
M 3 x 0,50	6,2 mm	MEBW03	130,00
M 4 x 0,70	6,2 mm	MEBW04	130,00
M 5 x 0,80	10 mm	MEBW05	165,00
M 6 x 1,00	10 mm	MEBW06	165,00
M 8 x 1,25	10 mm	MEBW08	165,00
M10 x 1,50	12 mm	MEBW10	214,00
M12 x 1,75	12 mm	MEBW12	214,00
M14 x 2,00	18 mm	MEBW14	350,00
M16 x 2,00	18 mm	MEBW16	370,00
M20 x 2,50	18 mm	MEBW20	653,00
M24 x 3,00	29 mm	MEBW24	995,00



***6fcWUg



DIN 338 - HSS Broca Mango Recto



DIN 338-A - HSS Broca Mango Reducido (13 or 16 mm)



DIN 345 - HSS Broca Mango Cónico

Ø	M	M	UNC	UNF	BSW	DIN	No.	€
4,20 mm	M 2 x 0,4	M 2,5 x 0,45				338	16142	1,60
4,70 mm	M 3 x 0,5		UNC 4 x 40	UNF 4 x 40		338	16147	1,60
5,60 mm	M 3,5 x 0,6		UNC 6 x 32	UNF 6 x 40		338	16156	3,40
6,10 mm	M 4 x 0,7		UNC 8 x 32	UNF 8 x 36		338	16161	2,80
7,50 mm	M 5 x 0,8		UNC 10 x 24	UNF 10 x 32		338	16175	3,00
9,30 mm	M 6 x 1,0		UNC 1/4 x 20	UNF 1/4 x 28	BSW 1/4 x 20	338	16193	4,00
11,30 mm	M 8 x 1,25		UNC 5/16 x 18	UNF 5/16 x 24	BSW 5/16 x 18	338	161113	5,00
12,40 mm	M 10 x 1,0*					338-A	161124	17,80
13,25 mm	M 10 x 1,5		UNC 3/8 x 16	UNF 3/8 x 24	BSW 3/8 x 16	338-A	111132	19,90
14,50 mm	M 12 x 1,25*					338-A	111145	23,70
15,25 mm	M 12 x 1,75		UNC 7/16 x 14	UNF 7/16 x 20	BSW 7/16 x 14	338-A	111152	35,90
17,00 mm	M 14 x 2,0	M 14 x 1,25*	UNC 1/2 x 13	UNF 1/2 x 20	BSW 1/2 x 13	338-A	111170	35,90
19,00 mm	M 16 x 2,0		UNC 5/8 x 11	UNF 5/8 x 18	BSW 5/8 x 11	338-A	111190	44,50
21,00 mm	M 18 x 2,5					338-A	111210	63,70
25,00 mm	M 20 x 2,5	M 22 x 2,5	UNC 3/4 x 10	UNF 3/4 x 16		338-A	111250	86,00
29,00 mm	M 24 x 3,0					338-A	111290	127,00
33,00 mm	M 27 x 3,0					345	130330	175,00
35,00 mm	M 30 x 3,5					345	130350	195,00

* para casquillos rosca bujía

Los diámetros de brocas son diámetros aproximados. Los materiales difíciles y duros necesitan un mayor diámetro que los materiales blandos.

Avellanador HSSG

con 1/4" Bit hexagonal
para avellanar el taladro



Ø	M	UNC	UNF	BSW		No.	€
10,4 mm	M 2 x 0,4 - M 6 x 1,0	UNC 4 x 40 - UNC 1/4	UNF 4 x 48 - UNF 1/4		1/4"	9402	17,90
16,5 mm	M 8 x 1,25 - M 12 x 1,75	UNC 5/16 - UNC 7/16	UNF 5/16 - UNF 7/16	BSW 1/4 - BSW 7/16	1/4"	9403	19,50

Generalmente no es necesario para avellanar el agujero de perforación. Sin embargo, nosotros recomendamos un avellanado para evitar la deformación de la superficie de la pieza al enroscar el casquillo.

Tuerca adaptador

1/4" hexágono Interno a 10 mm de hexágono Externo

internal hexagon	external hexagon	No.	€
1/4"	10 mm	9501	5,60

